



## KRIZA V.2

Recessed Mounted 56 W Spot LED Luminaire

Order Code : 3236296  
Product Code : KRZ 056A 40SD00 40 6K7 2X V.2 FLP



### Product Data

#### Standard Features

Housing	: Aluminium injection housing
Diffuser	: 40° Reflector
Ceiling Type	: Plasterboard
IP Grade	: IP20
Installation	: Recessed mounted
Light Source	: COB LED
Electronic Control	: On/Off

#### Optical & Electrical Features

Power Consumption	: 56 W
Final Luminous Flux	: 6660 lm
Efficacy	: 121 lm/W
Input Voltage	: 220-240 V AC
Frequency	: 50-60 Hz
Power Factor	: $\cos \phi > 0,9$
Correlated Color Temperature	: 4000K
Color Rendering Index	: >80

\* There is  $\pm 10\%$  Tolerance in Technical Values.

### Photometric Curve

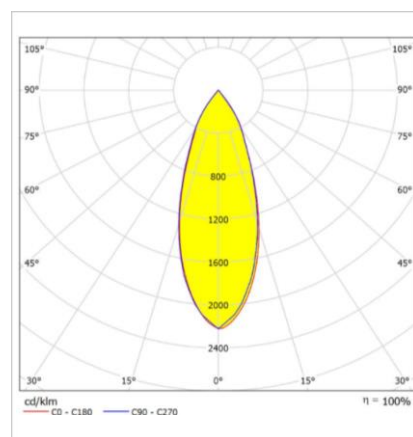

#### Other Features & Conditions

Operating Temperature Range	: -5 °C / +35 °C
Operating Temperature Range With Emergency Kit	: +10 °C / +35 °C
Impact Resistance	: IK03
Led Life Time - L70	: 72.000 hours @Ta= 35 °C

#### Optional Features

Correlated Color Temperatures	: 2700K / 3000K / 6500K
Emergency Kit Options	: 1 / 3 hours
DALI Option	: Yes
Degree Option	: 24° / 60°

## KRIZA V.2

Recessed Mounted 56 W Spot LED Luminaire

3236296 KRZ 056A 40SD00 40 6K7 2X V.2 FLP

### Dimensions (mm)

	a	b	h	d1 X d2
Standard	155	285	120	265x140

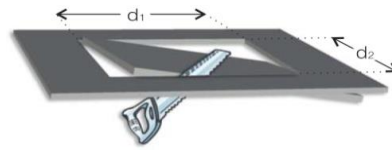
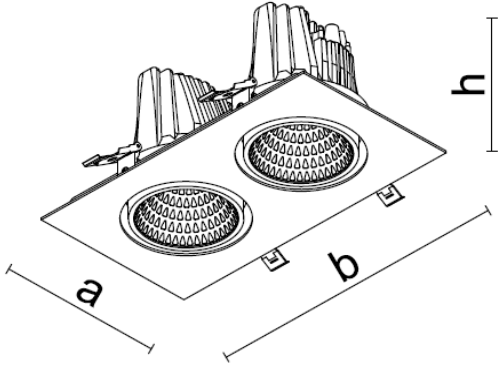

### Weight (kg)

Standart	2.700
----------	-------

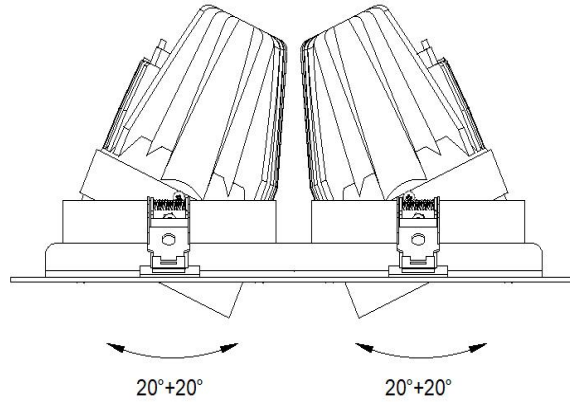

- EAE, reserves the right to make changes without prior notice.

**engineering the light**

EAE Aydınlatma A.Ş.

İkitelli Organize Sanayi Bölgesi Eski Turgut Özal Caddesi No:20 Başakşehir / İSTANBUL-TURKEY

Phone: +90 212 413 21 00 (pbx) Fax: +90 212 549 37 90

www.eaeaydinlatma.com.tr

Revision date: 05.12.2022