



Order Code : 3099588
 Product Code : STL 008A 40OD00 0K7 60TK3I LN2XST

Product Data

Standard Features

Housing	: RAL 7047 Powder finished aluminium extrusion housing, aluminium injection cover
Diffuser	: Glare minimizing highly permeable diffuser
Ceiling Type	: Plasterboard
IP Grade	: IP40
Installation	: Recessed mounted
Light Source	: Mid Power LED

Optical & Electrical Features

Power Consumption	: 8.9 W
Final Luminous Flux	: 790.9 lm
Efficacy	: 87.9 lm/W
Input Voltage	: 220-240 V AC
Frequency	: 50-60 Hz
Power Factor	: > 0,9
Surge Transient Protection	: 1 kV
Drive Current	: 200 mA
Correlated Color Temperature	: 4000K
Color Rendering Index	: >80

*There is ±%10 tolerance in the technical values.

Other Features & Conditions

Operating Temperature Range	: -25 °C/+40 °C
Impact Resistance	: IK02
Led Life Time - L70	: > 72.000 hours @Ta= 40 °C

STL

9 W Recessed Mounted Single Module
 Linear LED Luminaire



Photometric Curve

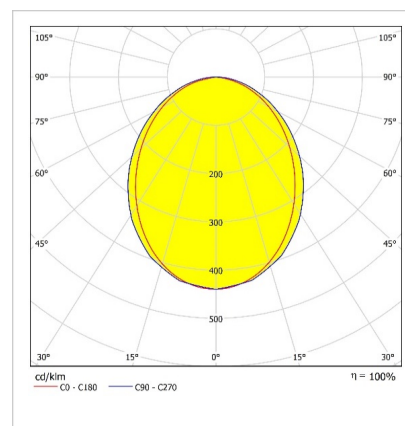

Optional Features

Correlated Color Temperatures	: 2700K, 3000K
Emergency Kit Options	: No
DALI Option	: Yes
Color Option	: RAL 9005

STL

9 W Recessed Mounted Single Module Linear LED Luminaire

3099588 STL 008A 40OD00 0K7 60TK3I LN2XST

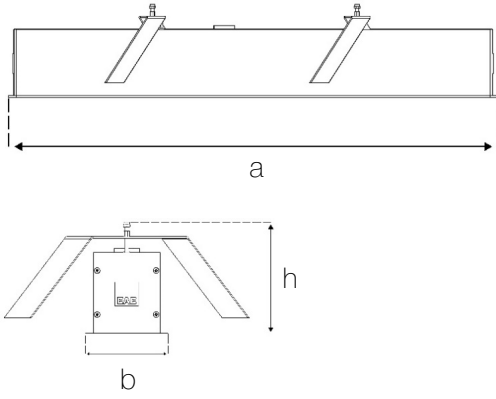

Dimensions (mm)

	a	b	h	d ¹ , d ²
Single Module	626	86	120	615x79
Starting Module	612	86	120	608x79
Finishing Module	612	86	120	608x79
Intermediate Module	602	86	120	602x79

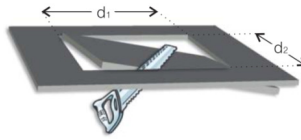

Weight (kg)

Standard	2,3
----------	-----

Installation System



Single (TK)

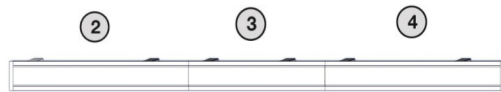

Starting (BS) Intermediate (AR) Finishing (SN)



Starting (BS) Finishing (SN)

1

Ordering Code : 3099588

Product Code : STL 008A 40OD00 0K7
60TK3I LN2XST

Module Model : Single (TK)

2

Ordering Code : 3099589

Product Code : STL 008A 40OD00 0K7
60BS3I LN2XST

Module Model : Starting (BS)

3

Ordering Code : 3099587

Product Code : STL 008A 40OD00 0K7
60AR3I LN2XST

Module Model : Intermediate (AR)

4

Ordering Code : 3099590

Product Code : STL 008A 40OD00 0K7
60SN3I LN2XST

Module Model : Finishing (SN)

- EAE, reserves the right to make changes without prior notice.



Revision date: 09.02.2020